

Roxtec ComSeal™



EN The Roxtec ComSeal™ is a light-weight and area efficient cable sealing solution for cabinets. The frames are made out of cast aluminum and the solutions are approved for IP 55 and UL/NEMA 12, 12K. They are equipped with adaptable sealing modules and supplied as readymade kits.

- Available in six different sizes
- For use with Group CM components
- Attached on inside or outside of cabinet

SE Roxtec ComSeal™ är en lätt och utrymmeseffektiv lösning för kabeltätning i skåp. Ramarna är gjutna i aluminium och lösningarna är godkända för IP 55 och UL/NEMA 12, 12K. De är försedda med anpassningsbara tätningmoduler och levereras som kompletta kit.

- Finns i sex olika storlekar
- För användning med komponenter ur Grupp CM
- Fästs på in- eller utsidan av skåpet

FI Roxtec ComSeal™ on kevyt ja tilankäytöltään tehokas kaapeliläpiviennin kaappeihin ja koteloihin. Kehykset on valmistettu valetusta alumiinista ja tuotteet on hyväksytyt IP 55 ja UL /NEMA 12, 12K mukaan. Ne on varustettu tiivistysmoduuleilla ja toimitetaan valmiina kittäinä.

- Saatavana kuutena eri kokona
- Käytetään CM-tuoteryhmän komponenttien kanssa
- Kiinnitetään kaapin tai kotelon sisä- tai ulkopuolelle

IT Roxtec ComSeal™ e' una soluzione per la sigillatura dei cavi efficace e leggera ideata per i cabinets. I telai sono in alluminio pressofuso e le soluzioni sono approvate per IP 55 e UL/NEMA 12, 12K. Tali soluzioni sono dotate di moduli di sigillatura adattabili e fornite sotto forma di kit pronti all'uso.

- Disponibile in sei diverse misure
- Da utilizzare con componenti del gruppo CM
- Da applicare all'interno o all'esterno dei cabinets

RU Roxtec ComSeal™ представляет собой легкое и эффективное уплотнение для ввода кабелей в шкафы. Рамы изготовлены из литого алюминия, уплотнители имеют разрешения IP 55 и UL/NEMA 12, 12K. Поставляются с набором уплотнительных модулей, изменяемого диаметра в комплекте.

- Выпускается в шести различных размерах
- Для использования с группой продукции CM
- Возможность монтировать снаружи или изнутри шкафа

ComSeal™ kit, integrated compression unit, aluminum

Alumiiniset ComSeal™-kitit, integroitu puristinyksikkö ▶ Рамы ComSeal™, интегрированный компрессионный блок, алюминиевые ▶ ComSeal™ kit, integrerad kompressionsenhet, aluminium ▶ Telai ComSeal™, unità di compressione integrata, alluminio



ComSeal™ 10



ComSeal™ 12



ComSeal™ 15



ComSeal™ 16



ComSeal™ 30



ComSeal™ 32

See also Installation guidelines on page 189.

RATINGS	IP: 55	UL/NEMA: 3, 12, 12K
---------	--------	---------------------

FI RU SE IT EN	Kit	Halkaisijavälit ja kaapelien / putkien lukumäärä			Paino (kg) (lb)	Tuotenumero
	Комплект	Диапазон диаметров и количество кабелей/труб			Вес (кг) (фунт)	Арт.№
	Kit	Diametermått och antal kablar/rör			Vikt (kg) (lb)	Artikelnummer
	Kit	Diametri e numero di cavi/tubi			Peso (kg) (lb)	Art.Nr.
	Kit	Diameter range and number of cables/pipes			Weight (kg) (lb)	Art No.
		0+3.5-16.5 mm 0+0.138-0.650 in (CM 20W40)	0+9.5-32.5 mm 0+0.374-1.280 in (CM 40 10-32)	0+28-43 mm 0+1.102-1.693 in (CM 50)		
	ComSeal™ 10/4	2 cables/pipes	2 cables/pipes		0.515 1.13	105299
	ComSeal™ 10/7	6 cables/pipes	1 cable/pipe		0.515 1.13	105301
	ComSeal™ 10/10	10 cables/pipes			0.515 1.13	105302
	ComSeal™ 12/3		3 cables/pipes		0.61 1.34	105303
	ComSeal™ 12/6	4 cables/pipes	2 cables/pipes		0.61 1.34	105305
	ComSeal™ 12/9	8 cables/pipes	1 cable/pipe		0.61 1.34	105306
	ComSeal™ 12/12	12 cables/pipes			0.61 1.34	105307
	ComSeal™ 15/3			3 cables/pipes	0.91 2.0	105308
	ComSeal™ 16/4		4 cables/pipes		0.666 1.47	105310
	ComSeal™ 16/7	4 cables/pipes	3 cables/pipes		0.666 1.47	105312
	ComSeal™ 16/10	8 cables/pipes	2 cables/pipes		0.666 1.47	105313
	ComSeal™ 16/16	16 cables/pipes			0.666 1.47	105314
	ComSeal™ 30/6			6 cables/pipes	1.40 3.09	105315
	ComSeal™ 32/8		8 cables/pipes		1.259 2.78	105316
	ComSeal™ 32/14	8 cables/pipes	6 cables/pipes		1.259 2.78	105320
	ComSeal™ 32/20	16 cables/pipes	4 cables/pipes		1.259 2.78	105321
	ComSeal™ 32/32	32 cables/pipes			1.259 2.78	105322

ComSeal™ frame, technical information

ComSeal™-kehysten tekniset tiedot ▶ Рамы ComSeal™, техническая информация ▶ ComSeal™ ram, teknisk information ▶
Telai ComSeal™, informazioni tecniche

ComSeal™ 10

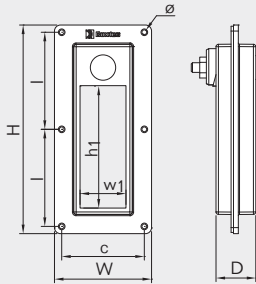

ComSeal™ 12

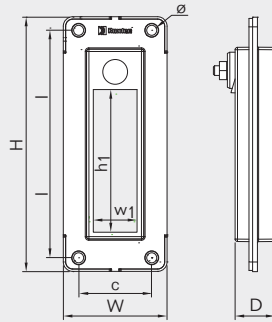

ComSeal™ 15

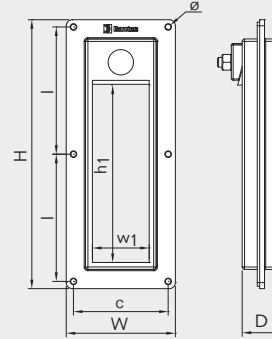

ComSeal™ 16

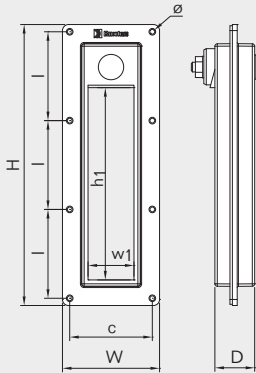

ComSeal™ 30

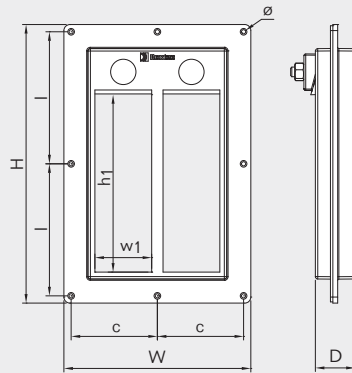

ComSeal™ 32

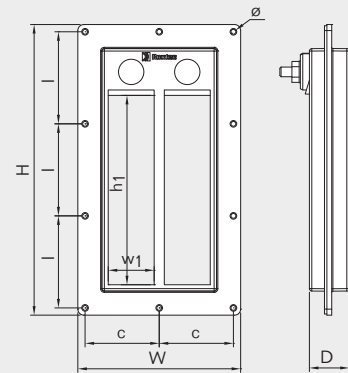

Pos	ComSeal™ 10		ComSeal™ 12		ComSeal™ 15		ComSeal™ 16		ComSeal™ 30		ComSeal™ 32	
	(mm)	(in)	(mm)	(in)	(mm)	(in)	(mm)	(in)	(mm)	(in)	(mm)	(in)
c	68.5	2.697	62	2.441	78.5	3.091	68.5	2.697	71.5	2.815	61.5	2.421
D	33	1.299	33	1.299	33	1.299	33	1.299	33	1.299	33	1.299
H	173	6.811	216	8.504	223	8.780	233	9.173	231	9.094	241	9.488
h ₁	100	3.937	120	4.724	150	5.906	160	6.299	150	5.906	160	6.299
l	80.5	3.169	193	7.598	105.5	4.154	73.7	2.902	109.5	4.311	76.33	3.005
w ₁	40	1.575	40	1.575	50	1.969	40	1.575	50	1.969	40	1.575
W	80.5	3.169	88	3.465	90.5	3.563	80.5	3.169	155	6.102	135	5.315
ø	5.5	0.217	8.5	0.335	5.5	0.217	5.5	0.217	5.5	0.217	5.5	0.217

Note: All dimensions are nominal values
Huomaa: Kaikki mitat ovat nimellisarvoja
Внимание: Все размеры номинальные
Obs: Angivna mått är nominella
Nota: tutte le dimensioni sono valori nominali

Roxtec ComSeal™ 12 fits the FL 21 knock-out
Roxtec ComSeal™ 12 sopii FL 21-aukkoon
Roxtec ComSeal™ 12 подходит для проемов FL 21
Roxtec ComSeal™ 12 passar FL 21-håltågningen
Roxtec ComSeal™ 12 compatibile con dima di foratura FL 21

ComSeal™ 10, 12, frames, holecut

Aukon koko ComSeal™ 10, 12-kehykselle
 ComSeal™ 10, 12 рамы, проёмы
 ComSeal™ 10, 12 håltagning
 Telai ComSeal™ 10, 12 dima di foratura

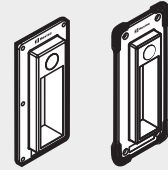

ComSeal™ 10

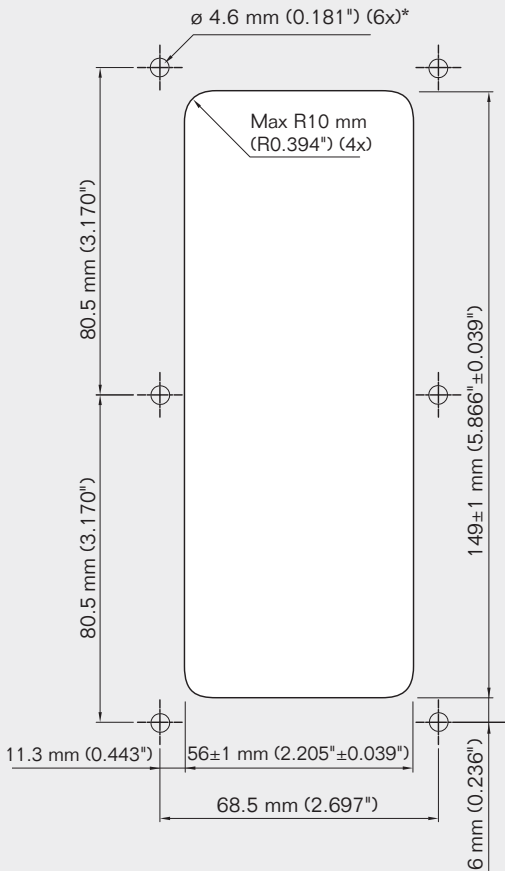

ComSeal™ 12

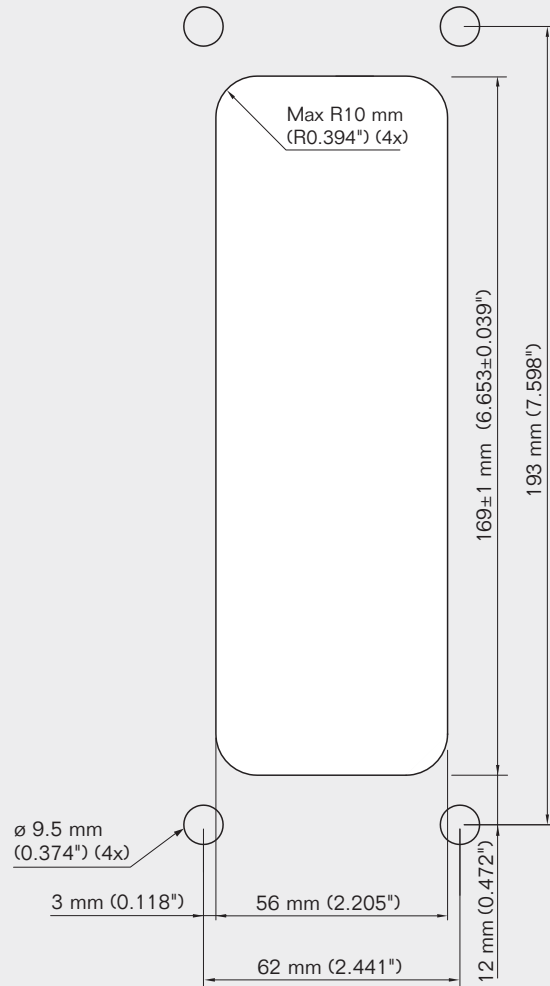

Roxtec ComSeal™ LW 12 fits FL 21 knock-out (holecut).

* $\varnothing 5.5$ (7/32"). Drill bit size when using nuts.

Not scale 1:1

ComSeal™ 15, 16 frames, holecut

Aukon koko ComSeal™ 15, 16-kehykselle
 ComSeal™ 15, 16 рамы, проёмы
 ComSeal™ 15, 16, håltagning
 Telai ComSeal™ 15, 16, dima di foratura

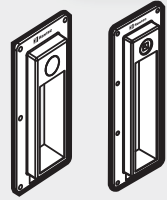

ComSeal™ 15

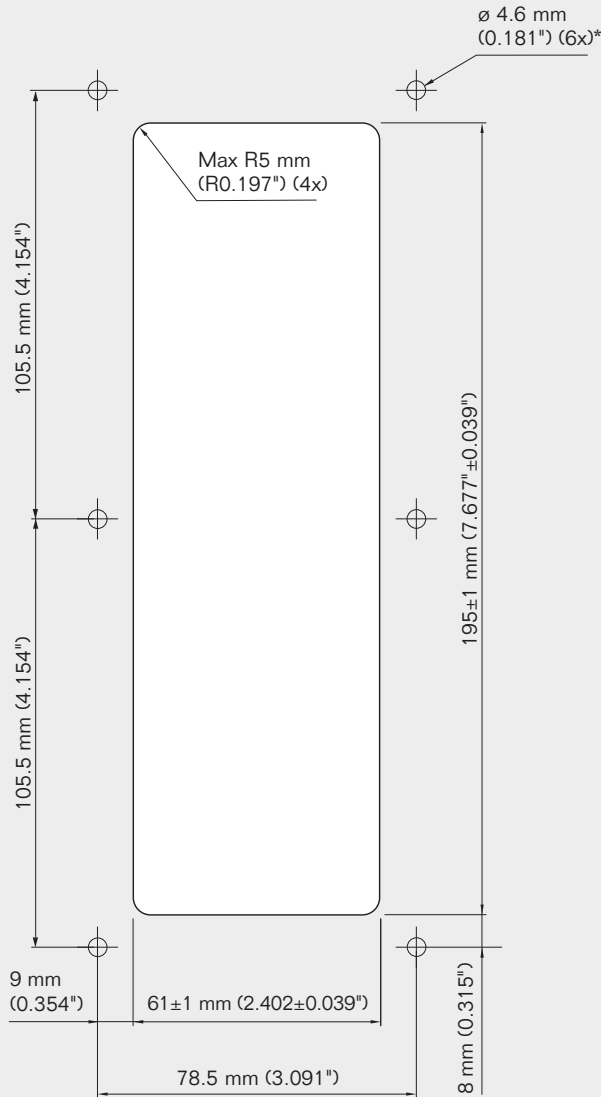

ComSeal™ 16

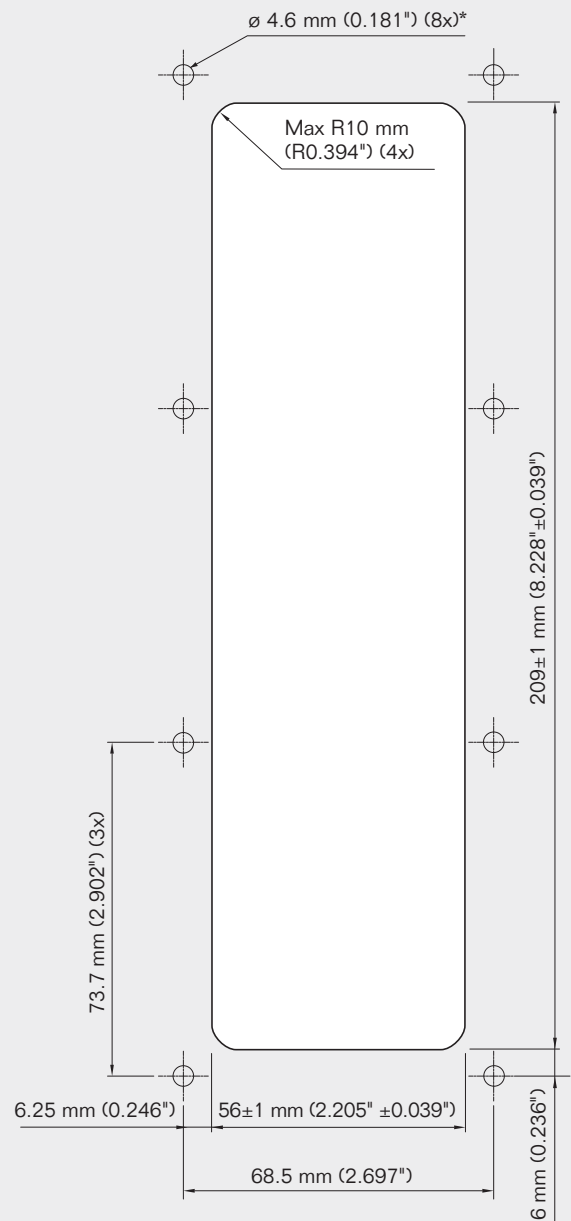

* \varnothing 5.5 (7/32"). Drill bit size when using nuts.

Not scale 1:1

ComSeal™ 30, 32 frame, holecut

Aukon koko ComSeal™ 30, 32-kehykselle

ComSeal™ 30, 32 рамы, проёмы

ComSeal™ 30, 32, håltagning

Telai ComSeal™ 30, 32, dima di foratura

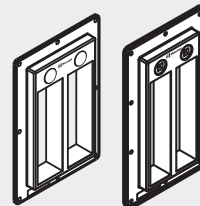

ComSeal™ 30

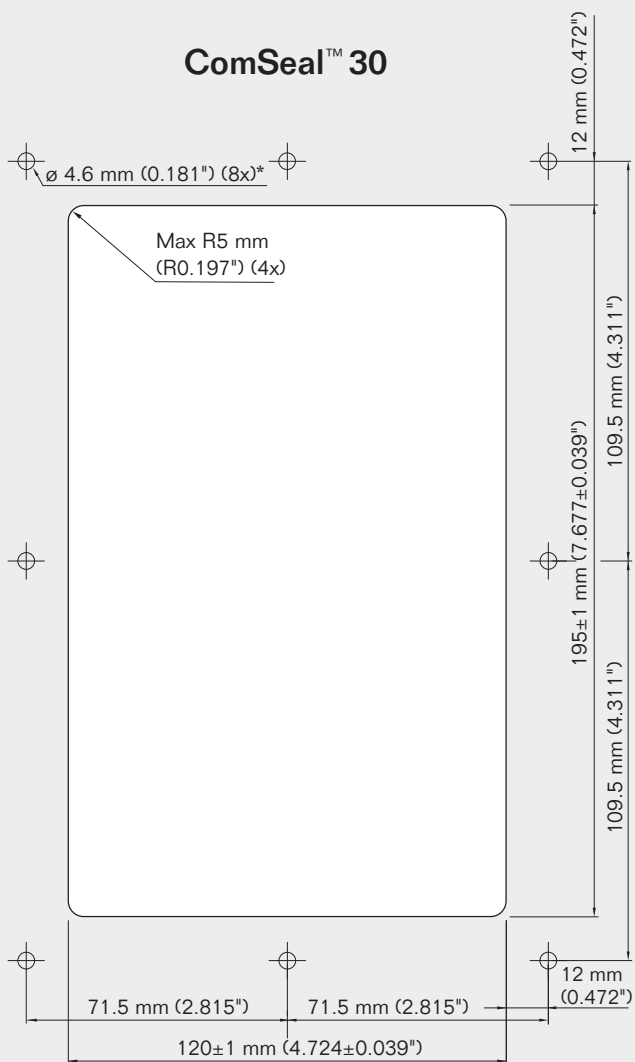

ComSeal™ 32

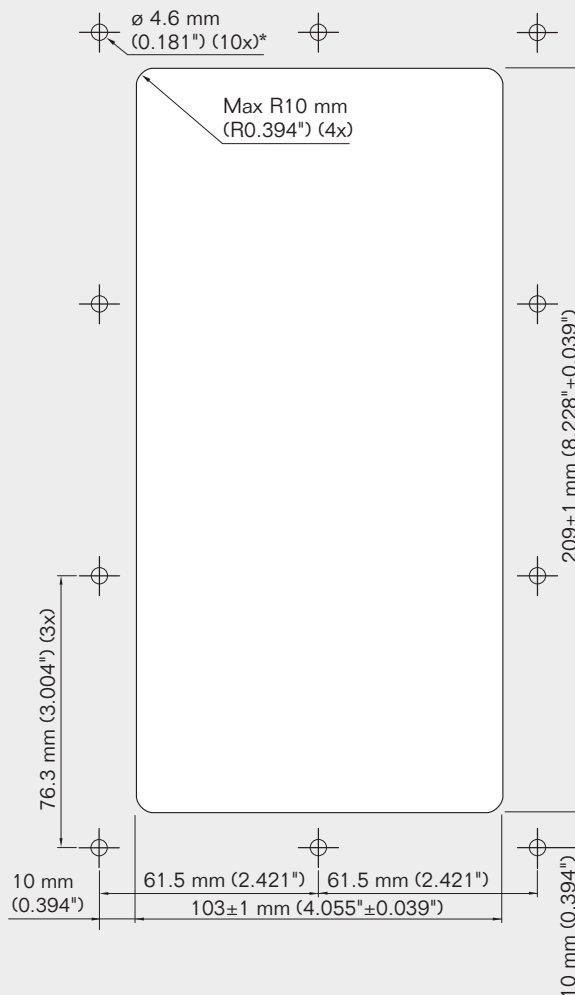

* \varnothing 5.5 (7/32"). Drill bit size when using nuts.

Not scale 1:1